

Surface Raceway / Aluminum SWA4326

Snap Way™ Accessories

Manufactured by MonoSystems, Inc.

SINGLE ROUND 1.59 COVER PLATE

General Information

- 1.) Assembly instructions: firmly press cover into place ensuring that both sides are completely snapped into base section.
- 2.) To remove cover: gently pry upward on base and cover seam with a non-abrasive tool such as a plastic putty knife.
- 3.) Receptacle device (ordered separately) wire per NEC and local codes.
- 4.) Views for reference - do not scale.

Material

#6063-T6 extruded aluminum, satin anodized finish.

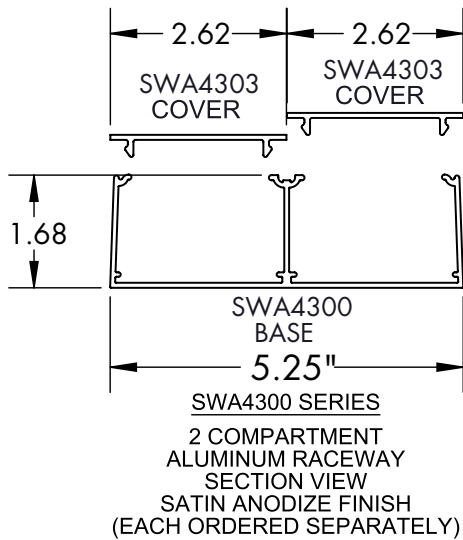

UL LISTED
FILE: E167318

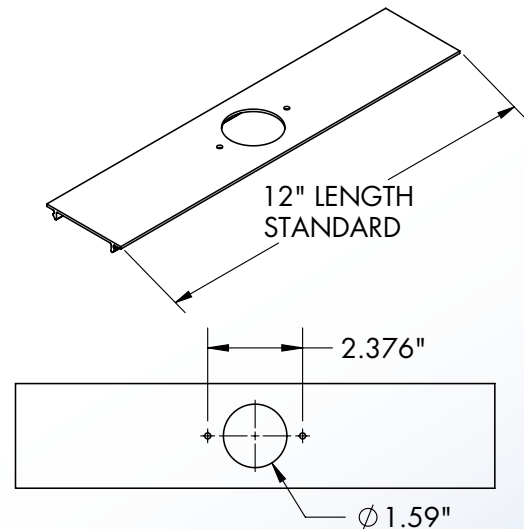
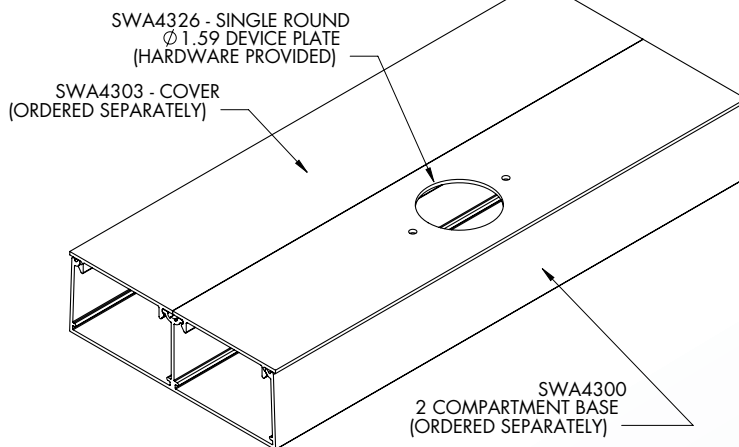

4 International Drive
Rye Brook, NY 10573
Toll Free: 1 888.764.7681
Phone: 914.934.2075
Fax: 914.934.2190
MonoSystems.com

