

Cable Tray / Channel Tray

SB-COVCL-06

Channel Tray Accessories
 Manufactured in the USA by MonoSystems, Inc.



COVER CLIP, 6" WIDE CHANNEL TRAY

Notes

- 1.) **To install:** attach cover clip around channel tray cover and tray assembly. Adjust each end around channel tray bottom until tension holds the clip in place.
To remove: insert a flat head screw driver (or similar) into slot in bottom angled flange and gently pry outward until clip is no longer captured around channel tray base.
- 2.) Clip material: 16ga 301 stainless steel.
- 3.) Ordered as each. For use with any material 6" wide channel tray.
- 4.) Views for reference - do not scale.

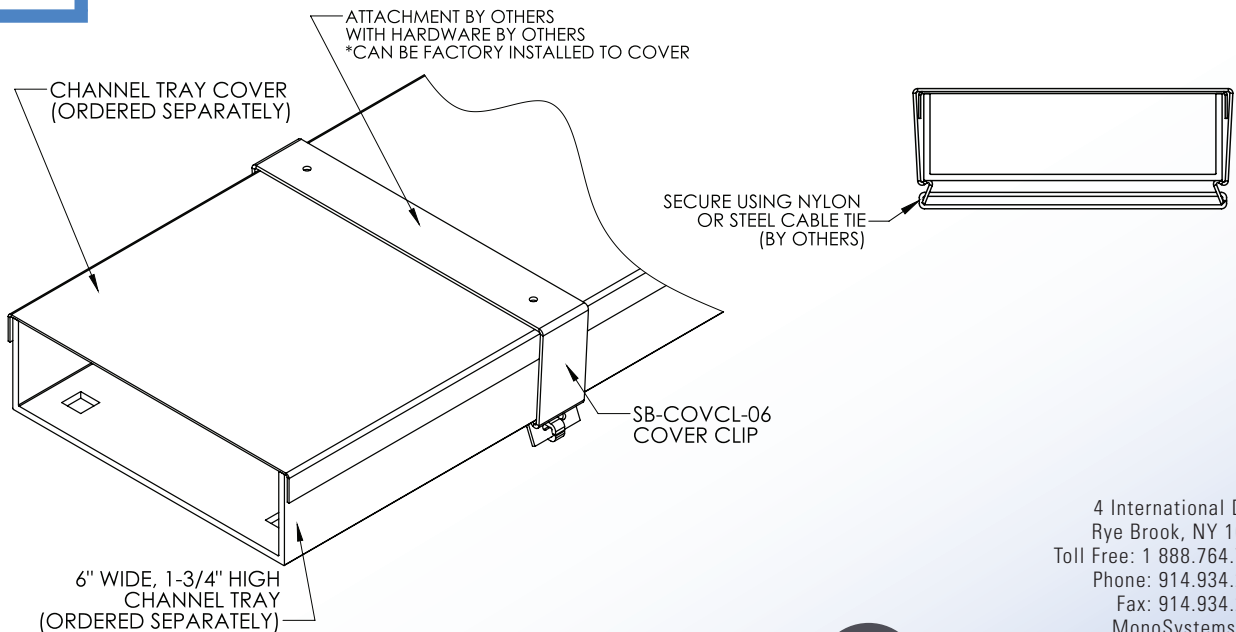
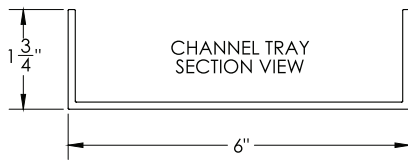
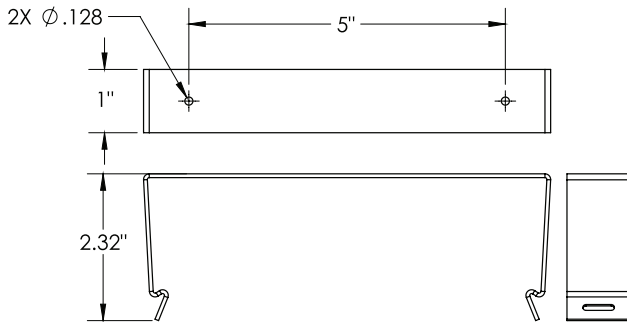

4 International Drive
 Rye Brook, NY 10573
 Toll Free: 1 888.764.7681
 Phone: 914.934.2075
 Fax: 914.934.2190
 MonoSystems.com

